

Public-law institution jointly founded by the federal states and the Federation

European Technical Assessment Body
for construction products



European Technical Assessment

ETA-24/0648
of 17 October 2024

English translation prepared by DIBt - Original version in German language

General Part

Technical Assessment Body issuing the European Technical Assessment:

Deutsches Institut für Bautechnik

Trade name of the construction product

Injection System EJOT Multifix Hybrid /
SORMAT ITH Hybrid for rebar connection

Product family
to which the construction product belongs

Systems for post-installed rebar
connections with mortar

Manufacturer

EJOT SE & Co. KG
Market Unit Construction
In der Stockwiese 35
57334 Bad Laasphe
GERMANY

Manufacturing plant

EJOT Plant 24

This European Technical Assessment
contains

23 pages including 3 annexes which form an integral part
of this assessment

This European Technical Assessment is
issued in accordance with Regulation (EU)
No 305/2011, on the basis of

EAD 330087-01-0601, Edition 06/2021

The European Technical Assessment is issued by the Technical Assessment Body in its official language. Translations of this European Technical Assessment in other languages shall fully correspond to the original issued document and shall be identified as such.

Communication of this European Technical Assessment, including transmission by electronic means, shall be in full. However, partial reproduction may only be made with the written consent of the issuing Technical Assessment Body. Any partial reproduction shall be identified as such.

This European Technical Assessment may be withdrawn by the issuing Technical Assessment Body, in particular pursuant to information by the Commission in accordance with Article 25(3) of Regulation (EU) No 305/2011.

Specific Part

1 Technical description of the product

The subject of this European Technical Assessment is the post-installed connection, by anchoring or overlap connection joint, of reinforcing bars (rebars) in existing structures made of normal weight concrete, using the "Injection System EJOT Multifix Hybrid / SORMAT ITH Hybrid for rebar connection" in accordance with the regulations for reinforced concrete construction.

Reinforcing bars made of steel with a diameter ϕ from 8 to 32 mm or the tension anchor ZA from sizes M12 to M24 according to Annex A and injection mortar MULTIFIX HSF SEISMIC / Sormat ITH-HY Seismic are used for rebar connections. The rebar is placed into a drilled hole filled with injection mortar and is anchored via the bond between rebar, injection mortar and concrete.

The product description is given in Annex A.

2 Specification of the intended use in accordance with the applicable European assessment Document

The performances given in Section 3 are only valid if the rebar connection is used in compliance with the specifications and conditions given in Annex B.

The verifications and assessment methods on which this European Technical Assessment is based lead to the assumption of a working life of the rebar connections of at least 50 and/or 100 years. The indications given on the working life cannot be interpreted as a guarantee given by the producer, but are to be regarded only as a means for choosing the right products in relation to the expected economically reasonable working life of the works.

3 Performance of the product and references to the methods used for its assessment

3.1 Mechanical resistance and stability (BWR 1)

Essential characteristic	Performance
Characteristic resistance under static and quasi-static loading	See Annex C 1
Characteristic resistance under seismic loading	See Annex B 4 and C 2

3.2 Safety in case of fire (BWR 2)

Essential characteristic	Performance
Reaction to fire	Class A1
Resistance to fire	See Annex C 3 and C 4

4 Assessment and verification of constancy of performance (AVCP) system applied, with reference to its legal base

In accordance with European Assessment Document EAD No. 330087-01-0601, the applicable European legal act is: [96/582/EC].

The system to be applied is: 1

5 Technical details necessary for the implementation of the AVCP system, as provided for in the applicable European Assessment Document

Technical details necessary for the implementation of the AVCP system are laid down in the control plan deposited with Deutsches Institut für Bautechnik.

Issued in Berlin on 17 October 2024 by Deutsches Institut für Bautechnik

Dipl.-Ing. Beatrix Wittstock
Head of Section

beglaubigt:
Baderschneider

Installation post installed rebar

Figure A1: Overlapping joint for rebar connections of slabs and beams

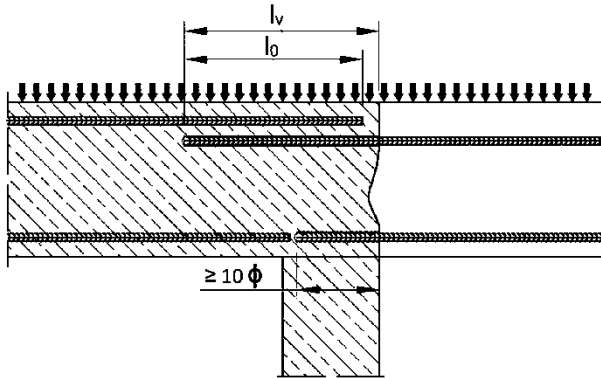

Figure A3: End anchoring of slabs or beams (e.g. designed as simply supported)

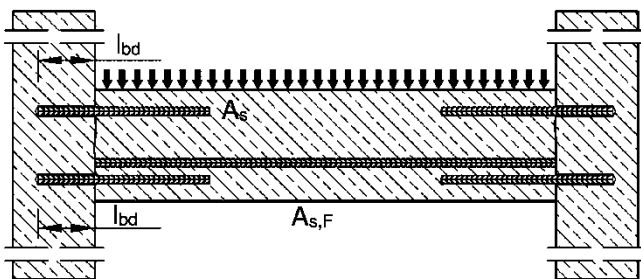

Figure A5: Anchoring of reinforcement to cover the line of acting tensile force

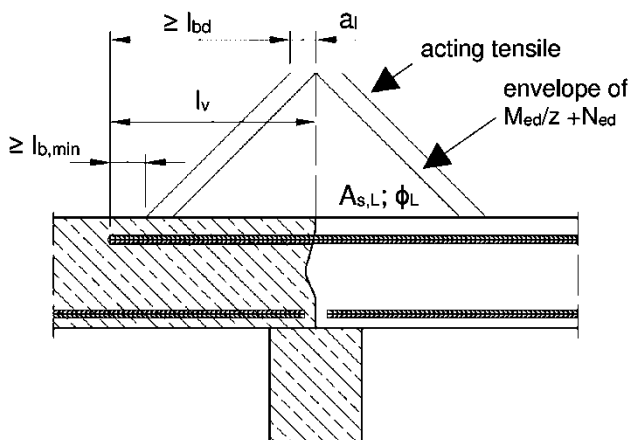

Figure A2: Overlapping joint at a foundation of a wall or column where the rebars are stressed in tension

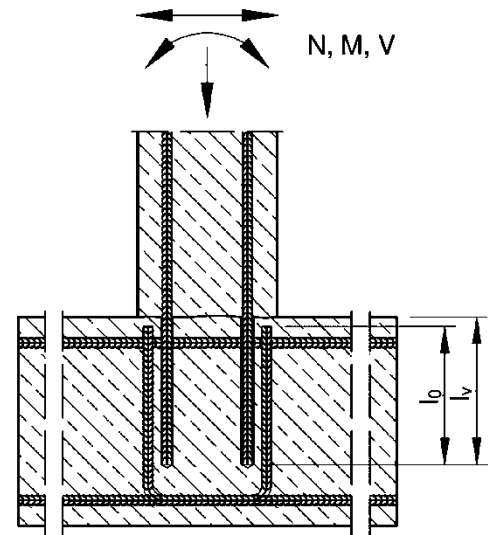
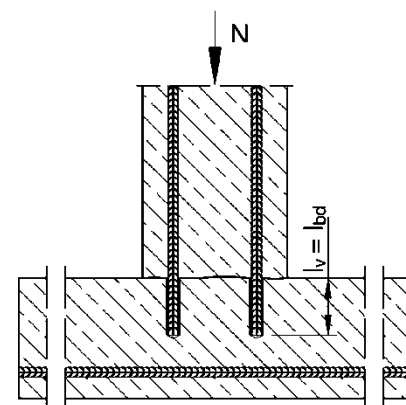

Figure A4: Rebar connection for components stressed primarily in compression. The rebars are stressed in compression



Note to Figure A1 to A5:

In the Figures no transverse reinforcement is plotted, the transverse reinforcement shall comply with EN 1992-1-1:2011.

Preparing of joints according to Annex B 2

Injection System EJOT Multifix Hybrid / SORMAT ITH Hybrid for rebar connection

Product description
Installed condition and examples of use for rebars

Annex A 1

Installation tension anchor ZA

Figure A6: Anchorage of column to foundation with tension anchor ZA.

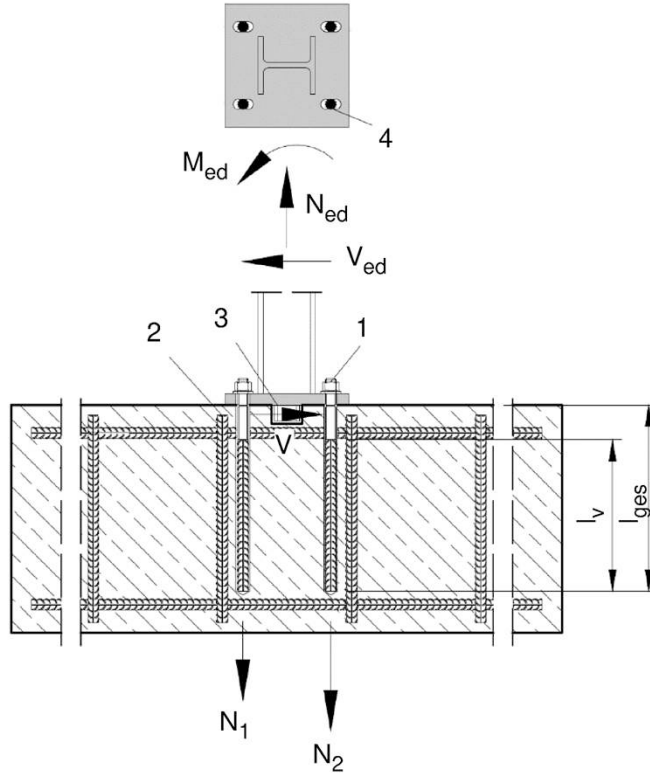

- 1 Tension anchor ZA (tension only)
- 2 Existing stirrup / reinforcement for overlap (lap splice)
- 3 Shear lug (or fastener loaded in shear)
- 4 Slotted hole with axial direction to the shear force

Figure A7: Anchorage of guardrail posts or cantilevered building components with tension anchor ZA and fastener.

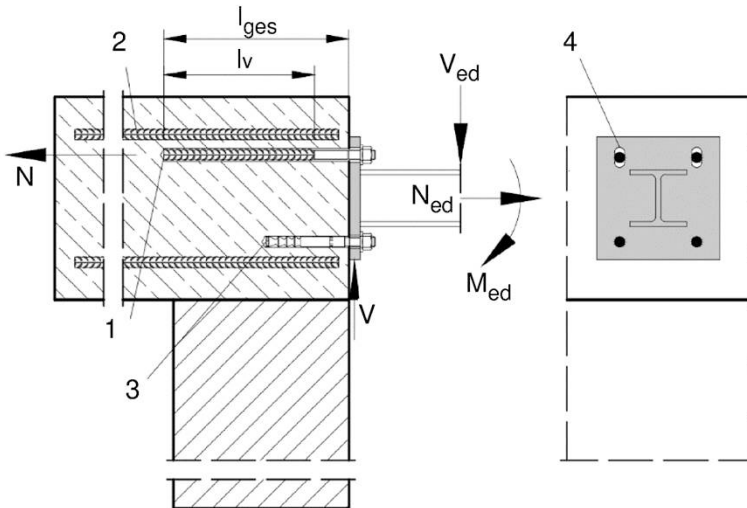

- 1 Tension anchor ZA (tension only)
- 2 Existing stirrup / reinforcement for overlap (lap splice)
- 3 Fastener (or shear lug loaded in shear)
- 4 Slotted hole with axial direction to the shear force

Note to Figure A6 and A7: In the Figures no transverse reinforcement is plotted, the transverse reinforcement shall comply with EN 1992-1-1:2011. The tension anchor may be only used for axial tensile force. The tensile force must be transferred by lap to the existing reinforcement of the building. The transfer of the shear force has to be ensured by suitable measures, e.g. by means of shear lugs or anchors with European Technical Assessment (ETA). General construction rules see Annex B 3

Injection System EJOT Multifix Hybrid / SORMAT ITH Hybrid for rebar connection

Product description

Installed condition and examples of use for tension anchors ZA

Annex A 2

Cartridge system

Coaxial Cartridge:

150 ml, 280 ml, 300 ml up to 333 ml and 380 ml up to 420 ml

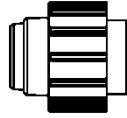

Imprint:

MULTIFIX HSF SEISMIC / Sormat ITH-HY Seismic
Processing and safety instructions, shelf life, charge number, manufacturer's information, quantity information

Side-by-Side Cartridge:

235 ml, 345 ml up to 360 ml and 825 ml

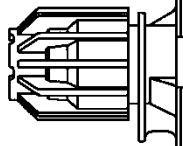

Imprint:

MULTIFIX HSF SEISMIC / Sormat ITH-HY Seismic

Processing and safety instructions, shelf life, charge number, manufacturer's information, quantity information

Static mixer PM-19E

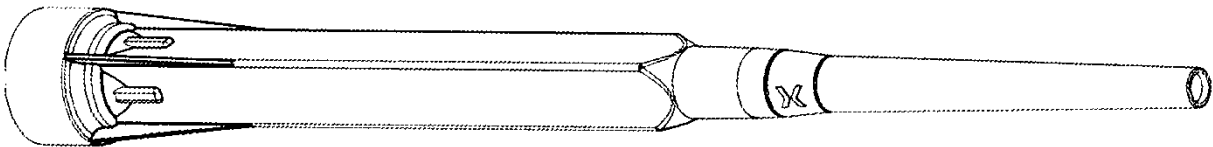

Piston plug VS und mixer extension VL

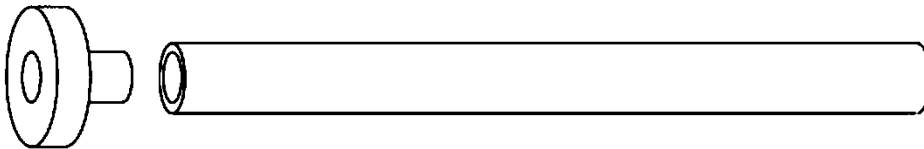

Injection System EJOT Multifix Hybrid / SORMAT ITH Hybrid for rebar connection

Product description
Injection system

Annex A 3

Reinforcing bar (rebar): $\varnothing 8$ up to $\varnothing 32$

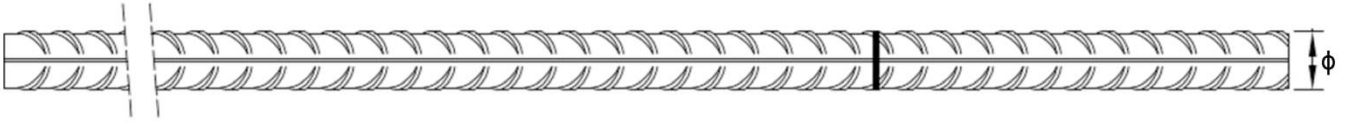

- Minimum value of related rip area $f_{R,min}$ according to EN 1992-1-1:2011
- Rib height of the bar shall be in the range $0,05\phi \leq h_{rib} \leq 0,07\phi$
(ϕ : Nominal diameter of the bar; h_{rib} : Rib height of the bar)

Table A1: Materials Rebar

Designation	Material
Rebar EN 1992-1-1:2011, Annex C	Bars and de-coiled rods class B or C f_{yk} and k according to NDP or NCI of EN 1992-1-1/NA $f_{uk} = f_{tk} = k \cdot f_{yk}$

Injection System EJOT Multifix Hybrid / SORMAT ITH Hybrid for rebar connection

Product description
Specifications Rebar

Annex A 4

Tension Anchor: ZA-M12 up to ZA-M24

Marking: e.g.  12 A4

-  Mark of the producer
- ZA Trade name
- 12 Rod diameter/thread
- A4 for stainless steel A4
- HCR for high corrosion resistance steel

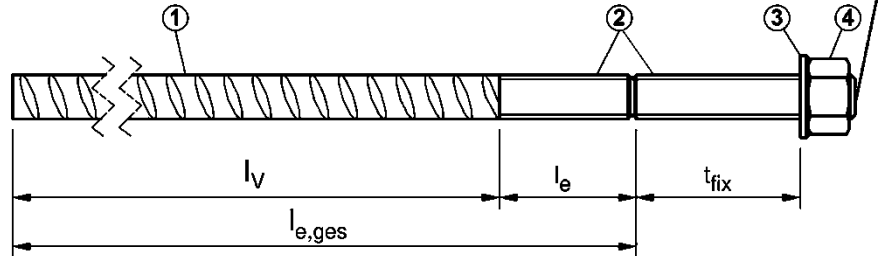

Table A2: Materials Tension Anchor ZA

Part	Designation	Material											
		ZA vz				ZA A4				ZA HCR			
		M12	M16	M20	M24	M12	M16	M20	M24	M12	M16	M20	M24
1	Reinforcement bar	Class B according to NDP or NCI of EN 1992-1-1/NA $f_{tk} = f_{tk} = k \cdot f_{yk}$											
	f_{yk} [N/mm ²]	500				500				500			
2	Threaded rod	Steel, zinc plated according to EN ISO 683-4:2018 or EN 10263:2021				Stainless steel, 1.4362, 1.4401, 1.4404, 1.4571, EN 10088-1:2014				High corrosion resistant steel, 1.4529, 1.4565, EN 10088-1:2014			
3	Washer	Steel, zinc plated according to EN ISO 683-4:2018 or EN 10263:2017				Stainless steel, 1.4362, 1.4401, 1.4404, 1.4571, EN 10088-1:2014				High corrosion resistant steel, 1.4529, 1.4565, EN 10088-1:2014			
4	Nut												

Table A3: Dimensions and installation parameters

Size			ZA-M12	ZA-M16	ZA-M20	ZA-M24	
Diameter of threaded rod	d_s	[mm]	12	16	20	24	
Diameter of reinforcement bar	ϕ	[mm]	12	16	20	25	
Drill hole diameter	d_o	[mm]	16	20	25	32	
Diameter of clearance hole in fixture	d_f	[mm]	14	18	22	26	
With across nut flats	SW	[mm]	19	24	30	36	
Stress area	A_s	[mm ²]	84	157	245	353	
Effective embedment depth	l_v	[mm]	according to static calculation				
Length of bonded thread	plated	l_e	[mm]	≥ 20	≥ 20	≥ 20	≥ 20
	A4/HCR			≥ 100	≥ 100	≥ 100	≥ 100
Minimum thickness of fixture	min t_{fix}	[mm]	5	5	5	5	
Maximum thickness of fixture	max t_{fix}	[mm]	3000	3000	3000	3000	
Maximum installation torque	max T_{inst}	[Nm]	50	100	150	150	

Injection System EJOT Multifix Hybrid / SORMAT ITH Hybrid for rebar connection

Product description
Specifications Tension Anchor ZA

Annex A 5

Specification of the intended use			
Anchorage subject to:		working life 50 years	working life 100 years
HD: Hammer drilling HDB: Hammer drilling with hollow drill bit CD: Compressed air drilling	Static and quasi-static loads	Ø8 to Ø32 ZA-M12 to ZA-M24	Ø8 to Ø32 ZA-M12 to ZA-M24
	Seismic action	Ø10 to Ø32	Ø10 to Ø32
	Fire exposure	Ø8 to Ø32 ZA-M12 to ZA-M24	Ø8 to Ø32 ZA-M12 to ZA-M24
Temperature Range:	- 40°C to +80°C (max long-term temperature +50 °C and max short-term temperature +80 °C)		
Base materials:			
<ul style="list-style-type: none"> - Reinforced or unreinforced normal weight concrete according to EN 206:2013 + A1:2016. - Strength classes C12/15 to C50/60 according to EN 206:2013 + A1:2016. - Maximum chloride content of 0,40% (CL 0.40) related to the cement content according to EN 206:2013 + A1:2016. - Non-carbonated concrete. <p>Note: In case of a carbonated surface of the existing concrete structure the carbonated layer shall be removed in the area of the post-installed rebar connection with a diameter of $\phi + 60$ mm prior to the installation of the new rebar.</p> <p>The depth of concrete to be removed shall correspond to at least the minimum concrete cover in accordance with EN 1992-1-1:2011. The foregoing may be neglected if building components are new and not carbonated and if building components are in dry conditions.</p>			
Use conditions (Environmental conditions) with tension anchor ZA:			
<ul style="list-style-type: none"> - Structures subject to dry internal conditions (all materials). - For all other conditions according to EN 1993-1-4:2006 + A1:2015 corresponding to corrosion resistance class: <ul style="list-style-type: none"> • Stainless steel Stahl A4 according to Annex A 4, Table A1: CRC III • High corrosion resistance steel HCR according to Annex A 4, Table A1: CRC V 			
Design:			
<ul style="list-style-type: none"> - Anchorages are designed under the responsibility of an engineer experienced in anchorages and concrete work. - Verifiable calculation notes and drawings are prepared taking account of the forces to be transmitted. - Design according to EN 1992-1-1:2020, EN 1992-1-2:2011 and Annex B 2 and B 3. - The actual position of the reinforcement in the existing structure shall be determined on the basis of the construction documentation and taken into account when designing. 			
Installation:			
<ul style="list-style-type: none"> - Dry or wet concrete. It must not be installed in flooded holes. - Overhead installation allowed. - Hole drilling by hammer drill (HD), hollow drill (HDB) or compressed air drill mode (CD). - The installation of post-installed rebar resp. tension anchors shall be done only by suitable trained installer and under supervision on site; the conditions under which an installer may be considered as suitable trained and the conditions for supervision on site are up to the Member States in which the installation is done. - Check the position of the existing rebars (if the position of existing rebars is not known, it shall be determined using a rebar detector suitable for this purpose as well as on the basis of the construction documentation and then marked on the building component for the overlap joint). 			
Injection System EJOT Multifix Hybrid / SORMAT ITH Hybrid for rebar connection			Annex B 1
Intended use Specifications			

Figure B1: General construction rules for post-installed rebars

- Only tension forces in the axis of the rebar may be transmitted.
- The transfer of shear forces between new concrete and existing structure shall be designed additionally according to EN 1992-1-1:2011.
- The joints for concreting must be roughened to at least such an extent that aggregate protrude.

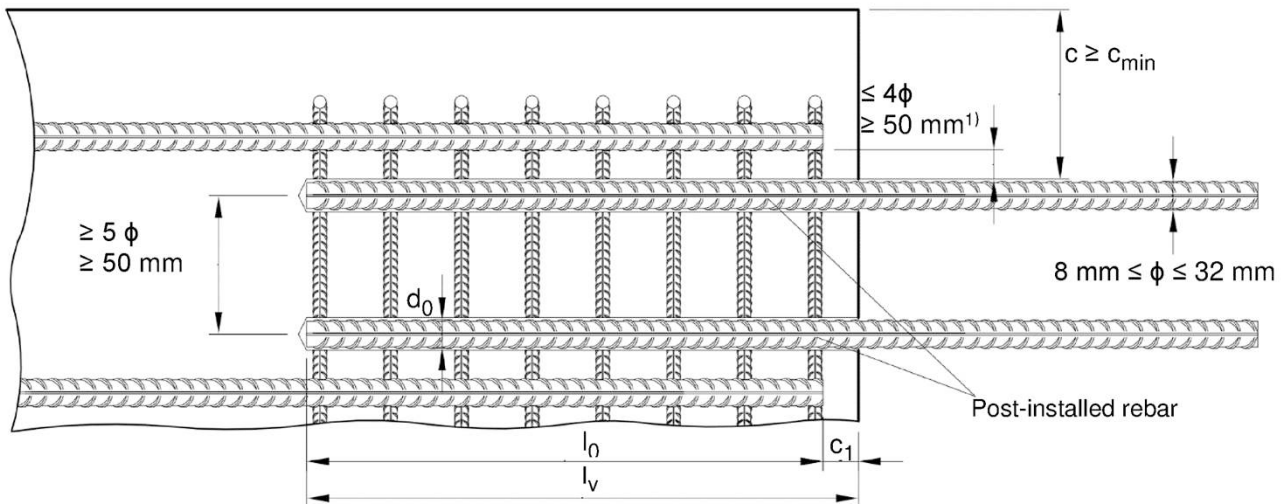

1) If the clear distance between lapped bars exceeds 4ϕ but at least 50 mm, then the lap length shall be increased by the difference between the clear bar distance and 4ϕ but at least 50 mm.

The following applies to Figure B1:

- c concrete cover of post-installed rebar
- c_1 concrete cover at end-face of existing rebar
- c_{\min} minimum concrete cover according to Table B1 and to EN 1992-1-1:2011, Section 4.4.1.2
- ϕ diameter of post-installed rebar
- l_0 lap length, according to EN 1992-1-1:2011, Section 8.7.3
- l_v effective embedment depth, $\geq l_0 + c_1$
- d_0 nominal drill bit diameter, see Annex B 5

Injection System EJOT Multifix Hybrid / SORMAT ITH Hybrid for rebar connection

Intended use
General construction rules for post-installed rebars

Annex B 2

Figure B2: General construction rules for tension anchors ZA

- The length of the bonded-in thread may not be accounted as anchorage.
- Only tension forces in the direction of the bar axis may be transmitted by the tension anchor ZA.
- The tension force must be transferred via an overlap joint to the reinforcement in the building part.
- The transfer of shear forces shall be ensured by appropriate additional measures, e.g. shear lugs or by anchors with an European technical assessment.
- In the anchor plate, the holes for the tension anchors shall be executed as elongated holes with axis in the direction of the shear force.

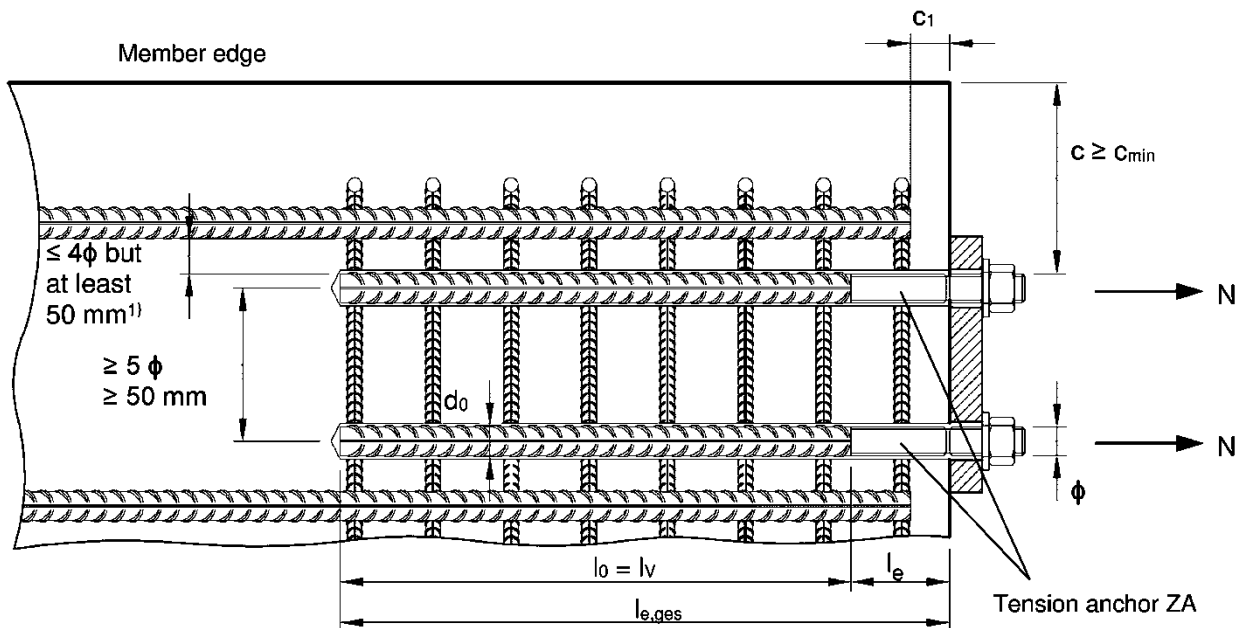

- 1) If the clear distance between lapped bars exceeds 4ϕ but at least 50 mm, then the lap length shall be increased by the difference between the clear bar distance and 4ϕ but at least 50 mm.

The following applies to Figure B2:

c	concrete cover of tension anchor ZA
c_1	concrete cover at end-face of existing rebar
c_{min}	minimum concrete cover according to Table B1 and to EN 1992-1-1:2011, Section 4.4.1.2
ϕ	diameter of tension anchor
l_0	lap length, according to EN 1992-1-1:2011, Section 8.7.3
l_v	effective embedment depth
l_e	length of bonded thread
$l_{e,ges}$	overall embedment depth, $\geq l_0 + c_2$
d_0	nominal drill bit diameter, see Annex B 5

Injection System EJOT Multifix Hybrid / SORMAT ITH Hybrid for rebar connection

Intended use
General construction rules for tension anchors

Annex B 3

Table B1: Minimum concrete cover $c_{min}^{1)}$ of post-installed rebar and tie rod ZA depending of drilling method

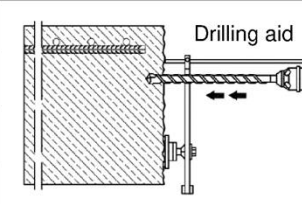
Drilling method	Rebar diameter	Without drilling aid	With drilling aid	
HD: Hammer drilling HDB: Hammer drilling with hollow drill bit	< 25 mm	30 mm + 0,06 · l_v ≥ 2 φ	30 mm + 0,02 · l_v ≥ 2 φ	
	≥ 25 mm	40 mm + 0,06 · l_v ≥ 2 φ	40 mm + 0,02 · l_v ≥ 2 φ	
CD: Compressed air drilling	< 25 mm	50 mm + 0,08 · l_v	50 mm + 0,02 · l_v	
	≥ 25 mm	60 mm + 0,08 · l_v ≥ 2 φ	60 mm + 0,02 · l_v ≥ 2 φ	

1) see Annex B 2, Figure B1 and Annex B 3, Figure B2









Comments: The minimum concrete cover acc. EN 1992-1-1:2011 must be observed.

For the minimum concrete cover $c_{min,seis}$ in case of a seismic action, see Table B2.

Table B2: Minimum concrete cover $c_{min,seis}$

Drilling method	Design conditions	Distance to 1st edge	Distance to 2nd edge
HD: Hammer drilling HDB: Hammer drilling with hollow drill bit CD: Compressed air drilling	Edge	≥ 2 φ	≥ 2 φ
	Corner	≥ 2 φ	≥ 2 φ

Table B3: Dispensing tools

Cartridge type/size	Hand tool		Pneumatic tool
Coaxial cartridges 150, 280, 300 up to 333 ml	 e.g. Type H297 / H244C		 e.g. Type TS 492 X
Coaxial cartridges 380 up to 420 ml	 e.g. Type CCM 380/10	 e.g. Type H 285 or H244C	 e.g. Type TS 485 LX
Side-by-side cartridges 235, 345 ml	 e.g. Type CBM 330A	 e.g. Type H 260	 e.g. Type TS 477 LX
Side-by-side cartridge 825 ml	-	-	 e.g. Type TS 498X

All cartridges could also be extruded by a battery tool.

Injection System EJOT Multifix Hybrid / SORMAT ITH Hybrid for rebar connection

Intended use
Minimum concrete cover
Dispensing, cleaning and installation tools

Annex B 4

English translation prepared by DIBt

Table B4: Brushes, piston plugs, max anchorage depth and mixer extension, hammer (HD) and compressed air (CD) drilling

Bar size ϕ	Tension anchor ϕ	Drill bit - ϕ		d_b Brush - ϕ	$d_{b,min}$ min. Brush - ϕ	Piston plug	Cartridge: All sizes				Cartridge: 825 ml						
		HD	CD				Hand or battery tool		Pneumatic tool		Pneumatic tool						
							$l_{v,max}$	Mixer extension	$l_{v,max}$	Mixer extension	$l_{v,max}$	Mixer extension					
[mm]	[mm]	[mm]		[mm]	[mm]		[mm]		[mm]		[mm]						
8	-	10	-	RB10	11,5	10,5	-	250	VL10/0,75 or VL16/1,8	250	VL10/0,75 or VL16/1,8	250	VL10/0,75 or VL16/1,8				
	-		-	RB12	13,5	12,5	-	700		800		800					
10	-	12	-	RB14	15,5	14,5	VS14	250		250		250		1000	1000		
	-		-					700		1000		1000					
12	ZA-M12	14	-					250		250		250					
		16		RB16	17,5	16,5	VS16							1200			
14	-	18		RB18	20,0	18,5	VS18	700				1000		1400			
16	ZA-M16	20		RB20	22,0	20,5	VS20							1600			
20	ZA-M20	25	-	RB25	27,0	25,5	VS25	500		VL10/0,75 or VL16/1,8		700	VL10/0,75 or VL16/1,8	2000	VL16/1,8		
		-	26	RB26	28,0	26,5	VS26										
22	-	28		RB28	30,0	28,5	VS28										
24/25	ZA-M24	30		RB30	32,0	30,5	VS30										
		32		RB32	34,0	32,5	VS32										
28	-	35		RB35	37,0	35,5	VS35										
32	-	40		RB40	43,5	40,5	VS40										

Table B5: Brushes, piston plugs, max anchorage depth and mixer extension, hammer drilling with hollow drill bit system (HDB)

Bar size ϕ	Tension anchor ϕ	Drill bit - ϕ		d_b Brush - ϕ	$d_{b,min}$ min. Brush - ϕ	Piston plug	Cartridge: All sizes				Cartridge: 825 ml							
		HDB	Hand or battery tool				Pneumatic tool		Pneumatic tool									
			$l_{v,max}$				Mixer extension	$l_{v,max}$	Mixer extension	$l_{v,max}$	Mixer extension							
[mm]	[mm]	[mm]					[mm]		[mm]		[mm]							
8	-	10		No cleaning required				250	VL10/0,75 or VL 16/1,8	250	VL10/0,75 or VL16/1,8	250	VL10/0,75 or VL16/1,8					
	-		-					700		800		800						
10	-	12						250		250		250						
	-		-					700		1000		1000						
12	ZA-M12	14						VS14		250		250						
		16						VS16		700		1000	1000					
14	-	18						VS18										
16	ZA-M16	20						VS20										
20	ZA-M20	25						VS25										
22	-	28						VS28										
24/25	ZA-M24	30		VS30	500				VL10/0,75 or VL 16/1,8	700	VL10/0,75 or VL16/1,8	1000	VL16/1,8					
		32		VS32														
28	-	35		VS35														
32	-	40		VS40														

Injection System EJOT Multifix Hybrid / SORMAT ITH Hybrid for rebar connection

Intended Use
Parameter brushes, piston plugs, max anchorage depth and mixer extension

Annex B 5

Cleaning and installation tools

HDB – Hollow drill bit system



The hollow drill system consists of Heller Duster Expert hollow drill bit and a class M vacuum cleaner with a minimum negative pressure of 253 hPa and a flow rate of minimum 150 m³/h (42 l/s).

Hand pump

(Volume 750 ml, $h_0 \leq 10 d_s$, $d_0 \leq 20\text{mm}$)



Manual slide valve

(min 6 bar)



Brush RB



Piston Plug VS



Brush extension RBL



Table B6: Working time and curing time

Temperature in base material			Maximum working time	Minimum curing time ¹⁾
T			t_{work}	t_{cure}
- 5 °C	up to	- 1 °C	50 min	5 h
0 °C	up to	+ 4 °C	25 min	3,5 h
+ 5 °C	up to	+ 9 °C	15 min	2 h
+ 10 °C	up to	+ 14 °C	10 min	1 h
+ 15 °C	up to	+ 19 °C	6 min	40 min
+ 20 °C	up to	+ 29 °C	3 min	30 min
+ 30 °C	up to	+ 40 °C	2 min	30 min
Cartridge temperature			+5°C up to +40°C	

¹⁾ The minimum curing time is only valid for dry base material.
In wet base material the curing time must be doubled.

Injection System EJOT Multifix Hybrid / SORMAT ITH Hybrid for rebar connection

Intended Use

Cleaning and installation tools
Working time and curing time

Annex B 6

Installation instructions

Attention: Before drilling, remove carbonated concrete and clean contact areas (see Annex B1)
Aborted drill holes shall be filled with mortar.

Drilling of the bore hole

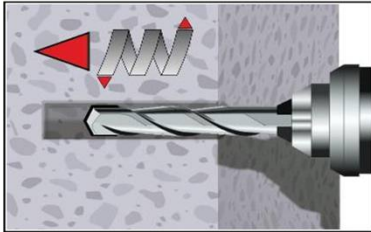

- 1a. Hammer drilling (HD) / Compressed air drilling (CD)**
Drill a hole to the required embedment depth.
Drill bit diameter according to Table B4.
Proceed with Step 2 (MAC or CAC).

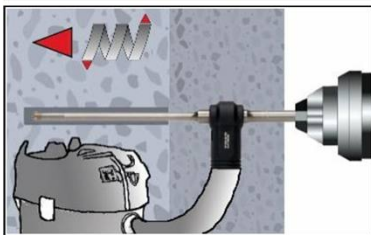

- 1b. Hollow drill bit system (HDB) (see Annex B 6)**
Drill a hole to the required embedment depth.
Drill bit diameter according to Table B5.
Proceed with Step 3.

Manual Air Cleaning (MAC)

for bore hole diameter $d_0 \leq 20\text{mm}$ and bore hole depth $h_0 \leq 10d_0$, with drilling method HD and CD

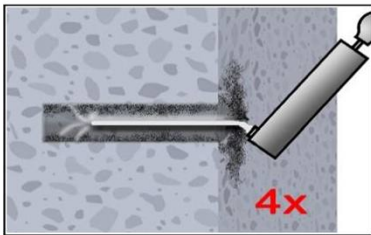

Attention! Standing water in the bore hole must be removed before cleaning.

- 2a.** Blow the bore hole clean minimum 4x from the bottom or back by hand pump (Annex B 6).

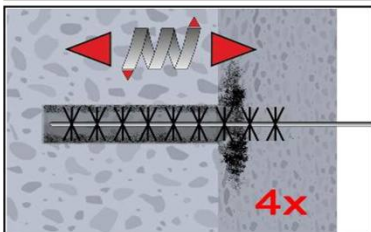

- 2b.** Brush the bore hole minimum 4x with brush RB according to Table B4 over the entire embedment depth in a twisting motion (if necessary, use a brush extension RBL).

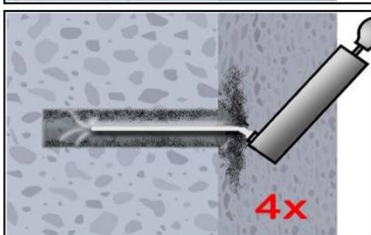

- 2c.** Finally blow the bore hole clean minimum 4x from the bottom or back by hand pump (Annex B 6).

Injection System EJOT Multifix Hybrid / SORMAT ITH Hybrid for rebar connection

Intended Use
Installation instruction

Annex B 7

Installation instructions (continuation)

Compressed Air Cleaning (CAC):

All diameter in cracked and uncracked concrete, with drilling method HD and CD

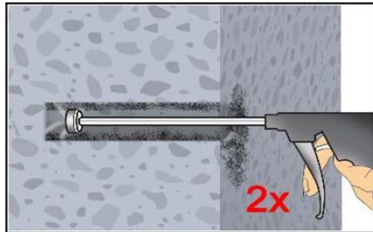

Attention! Standing water in the bore hole must be removed before cleaning.

2a. Blow the bore hole clean minimum 2x with compressed air (min. 6 bar) (Annex B 6) over the entire embedment depth until return air stream is free of noticeable dust. (If necessary, an extension shall be used.)

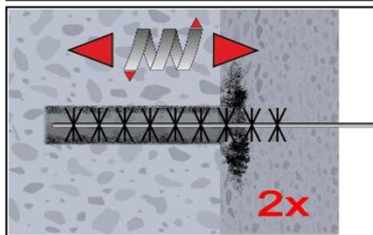

2b. Brush the bore hole minimum 2x with brush RB according to Table B4 over the entire embedment depth in a twisting motion. (If necessary, a brush extension RBL shall be used.)

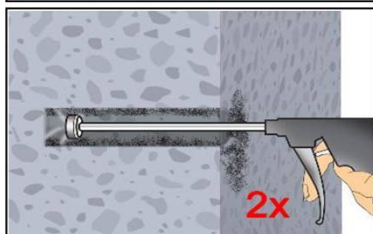

2c. Finally blow the bore hole clean minimum 2x with compressed air (min. 6 bar) (Annex B 6) over the entire embedment depth until return air stream is free of noticeable dust. (If necessary, an extension shall be used.)

Cleaned bore hole has to be protected against re-contamination in an appropriate way, If necessary, repeat cleaning process directly before dispensing the mortar.

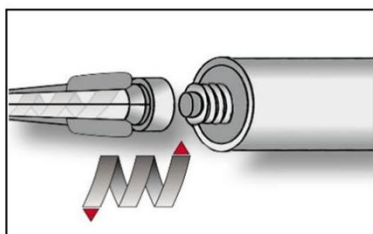

3. Screw on static-mixing nozzle PM-19E and load the cartridge into an appropriate dispensing tool.
For every working interruption longer than the maximum working time t_{work} (Annex B 6) as well as for new cartridges, a new static-mixer shall be used.

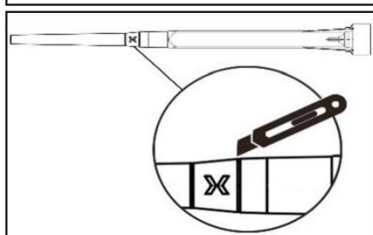

3a. In case of using the mixer extension VL16/1,8, the tip of the mixer nozzle has to be cut off at position „X“.

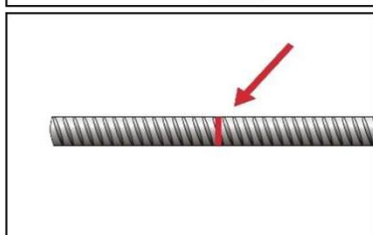

4. Mark embedment depth on the reinforcing bar.
The anchor rod shall be free of dirt, grease, oil or other foreign material.

Injection System EJOT Multifix Hybrid / SORMAT ITH Hybrid for rebar connection

Intended Use

Installation instructions (continuation)

Annex B 8

Installation instructions (continuation)

5. Injection tool must be marked by mortar level mark l_m and anchorage depth l_v resp. $l_{e,ges}$ with tape or marker.

Quick estimation: $l_m = 1/3 \cdot l_v$

Optimum mortar volume: $l_m = l_v \text{ resp. } l_{e,ges} \cdot \left(1,2 \cdot \frac{\phi^2}{d_0^2} - 0,2\right)$

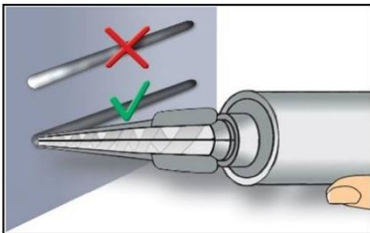
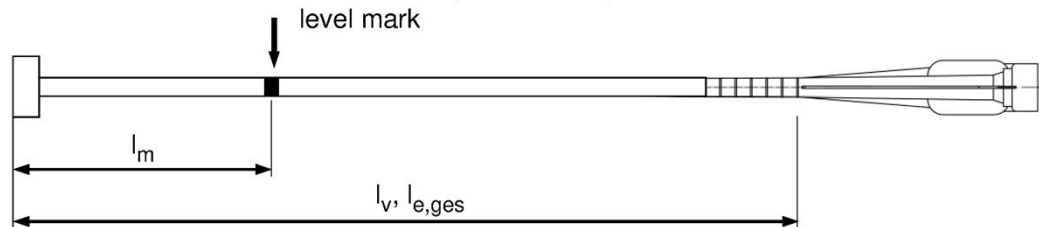

6. Not proper mixed mortar is not sufficient for fastening.
Dispense and discard mortar until a uniform grey colour is shown (at least 3 full strokes).

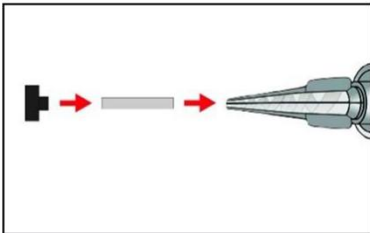

7. Piston plugs VS and mixer nozzle extensions VL shall be used according to Table B4 or B5
Assemble mixing nozzle, mixer extension and piston plug before injecting mortar.

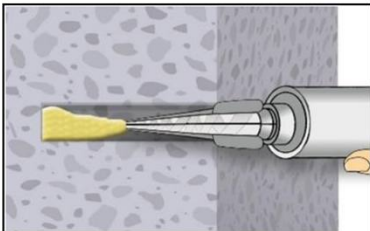

8a. **Injecting mortar without piston plug VS**
Starting at bottom of the hole and fill the hole up with mortar until the mortar level mark l_m is visible. (If necessary, a mixer nozzle extension shall be used.)
Slowly withdraw of the static mixing nozzle avoid creating air pockets
Observe the temperature related working time t_{work} (Annex B 6).

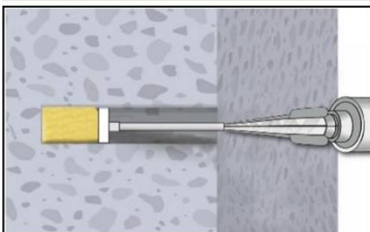

8b. **Injecting mortar with piston plug VS**
Insert piston plug to bottom of the hole and fill the hole with mortar until mortar level mark l_m is visible. (If necessary, a mixer nozzle extension shall be used.)
During injection the piston plug is pushed out of the bore hole by the back pressure of the mortar.
Observe the temperature related working time t_{work} (Annex B 6).

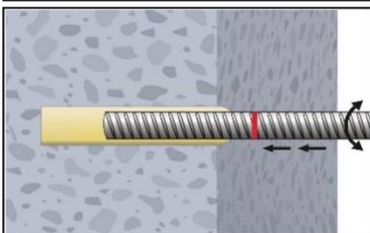

9. Insert the reinforcing bar while turning slightly up to the embedment mark.

Injection System EJOT Multifix Hybrid / SORMAT ITH Hybrid for rebar connection

Intended Use
Installation instructions (continuation)

Annex B 9

Installation instructions (continuation)

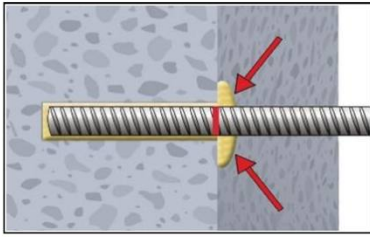

10. Annular gap between reinforcing bar and base material must be completely filled with mortar. Otherwise, the installation must be repeated starting from step 8 before the maximum working time t_{work} has expired.

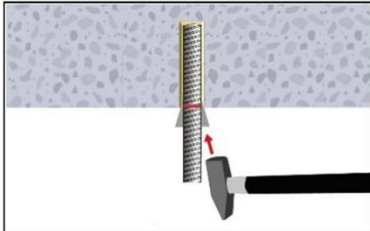

11. For application in vertical upwards direction the reinforcing bar shall be fixed (e.g. wedges).

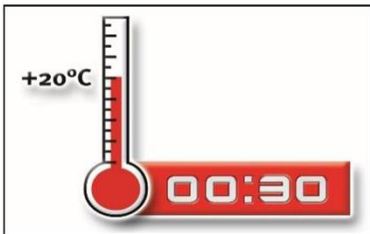

12. Temperature related curing time t_{cure} (Annex B 6) must be observed. Do not move or load the reinforcing bar during curing time.

Injection System EJOT Multifix Hybrid / SORMAT ITH Hybrid for rebar connection

Intended Use
Installation instructions (continuation)

Annex B 10

Table C1: Characteristic tension resistance for tension anchor ZA											
Tension Anchor			M12	M16	M20	M24					
Steel, zinc plated (ZA vz)											
Characteristic tension resistance	$N_{Rk,s}$	[kN]	67	125	196	282					
Partial factor	$\gamma_{Ms,N}$	[-]	1,4								
Stainless Steel (ZA A4 or ZA HCR)											
Characteristic tension resistance	$N_{Rk,s}$	[kN]	67	125	171	247					
Partial factor	$\gamma_{Ms,N}$	[-]	1,4		1,3	1,4					
Minimum anchorage length and minimum lap length under static or quasi-static loading											
The minimum anchorage length $l_{b,min}$ and the minimum lap length $l_{0,min}$ according to EN 1992-1-1:2011 ($l_{b,min}$ acc. to Eq. 8.6 and Eq. 8.7 and $l_{0,min}$ acc. to Eq. 8.11) shall be multiply by the amplification factor $\alpha_{lb} = \alpha_{lb,100y}$ according to Table C2.											
Table C2: Amplification factor $\alpha_{lb} = \alpha_{lb,100y}$ related to concrete class and drilling method; working life 50 and 100 years											
Concrete class		Drilling method		Bar size		Amplification factor $\alpha_{lb} = \alpha_{lb,100y}$					
C12/15 to C50/60		all drilling methods		8 mm to 32 mm ZA-M12 to ZA-M24		1,0					
Table C3: Reduction factor $k_b = k_{b,100y}$ for all drilling methods; working life 50 and 100 years											
Rebar		Concrete class									
ϕ		C12/15	C16/20	C20/25	C25/30	C30/37	C35/45	C40/50	C45/55	C50/60	
8 to 32 mm ZA-M12 to ZA-M24		1,0									
Table C4: Design values of the ultimate bond stress $f_{bd,PIR}$ and $f_{bd,PIR,100y}$ in N/mm² for all drilling methods and for good conditions; working life 50 and 100 years											
$f_{bd,PIR} = k_b \cdot f_{bd}$ $f_{bd,PIR,100y} = k_{b,100y} \cdot f_{bd}$ with f_{bd} : Design value of the ultimate bond stress in N/mm ² considering the concrete classes, the rebar diameter, the drilling method for good bond condition (for all other bond conditions multiply the values by $\eta_1 = 0.7$) and recommended partial factor $\gamma_c = 1,5$ according to EN 1992-1-1:2011. $k_b, k_{b,100y}$: Reduction factor according to Table C3											
Rebar		Concrete class									
ϕ		C12/15	C16/20	C20/25	C25/30	C30/37	C35/45	C40/50	C45/55	C50/60	
8 to 32 mm ZA-M12 to ZA-M24		1,6	2,0	2,3	2,7	3,0	3,4	3,7	4,0	4,3	
Injection System EJOT Multifix Hybrid / SORMAT ITH Hybrid for rebar connection							Annex C 1				
Performances Characteristic tension resistance for tension anchor, Minimum anchorage length and minimum lap length, Amplification factor, Reduction factor and Design values of ultimate bond resistance											

Minimum anchorage length and minimum lap length under seismic action

The minimum anchorage length $l_{b,min}$ and the minimum lap length $l_{0,min}$ according to EN 1992-1-1:2011 ($l_{b,min}$ acc. to Eq. 8.6 and Eq. 8.7 and $l_{0,min}$ acc. to Eq. 8.11) shall be multiply by the amplification factor $\alpha_{lb,seis} = \alpha_{lb,seis,100y}$ according to Table C5.

Table C5: Amplification factor $\alpha_{lb,seis} = \alpha_{lb,seis,100y}$ related to concrete class and drilling method; working life 50 and 100 years

Concrete class	Drilling method	Bar size	Amplification factor $\alpha_{lb,seis} = \alpha_{lb,seis,100y}$
C16/20 to C50/60	all drilling methods	10 mm to 32 mm	1,0

Table C6: Reduction factor $k_{b,seis} = k_{b,seis,100y}$ for all drilling methods; working life 50 and 100 years

Rebar ϕ	Concrete classes								
	C12/15	C16/20	C20/25	C25/30	C30/37	C35/45	C40/50	C45/55	C50/60
10 to 32 mm	No performance assessed	1,0							

Table C7: Design values of the ultimate bond stress $f_{bd,PIR,seis}$ and $f_{bd,PIR,seis,100y}$ in N/mm² for all drilling methods and for good conditions; working life 50 and 100 years

$$f_{bd,PIR,seis} = k_{b,seis} \cdot f_{bd}$$

$$f_{bd,PIR,seis,100y} = k_{b,seis,100y} \cdot f_{bd}$$

with

f_{bd} : Design value of the ultimate bond stress in N/mm² considering the concrete classes, the rebar diameter, the drilling method for good bond condition (for all other bond conditions multiply the values by $\eta_1 = 0.7$) and recommended partial factor $\gamma_c = 1,5$ according to EN 1992-1-1:2011.

$k_{b,seis}, k_{b,seis,100y}$: Reduction factor according to Table C6

Rebar ϕ	Concrete classes								
	C12/15	C16/20	C20/25	C25/30	C30/37	C35/45	C40/50	C45/55	C50/60
10 to 32 mm	No performance assessed	2,0	2,3	2,7	3,0	3,4	3,7	4,0	4,3

Injection System EJOT Multifix Hybrid / SORMAT ITH Hybrid for rebar connection

Performances

Minimum anchorage and lap length, Amplification factor, Reduction factor and Design values of ultimate bond stress under seismic action

Annex C 2

Design value of the ultimate bond stress $f_{bd,fi}$, $f_{bd,fi,100y}$ at increased temperature for concrete classes C12/15 to C50/60, (all drilling methods); working life 50 and 100 years:

The design value of the ultimate bond stress $f_{bd,fi}$, $f_{bd,fi,100y}$ at increased temperature has to be calculated by the following equation:

For working life 50 years: $f_{bd,fi} = k_{fi}(\theta) \cdot f_{bd,PIR} \cdot \gamma_c / \gamma_{M,fi}$
 with: $\theta \leq 364^\circ\text{C}$: $k_{fi}(\theta) = 30,34 \cdot e^{(\theta \cdot -0,011)} / (f_{bd,PIR} \cdot 4,3) \leq 1,0$
 $\theta > 364^\circ\text{C}$: $k_{fi}(\theta) = 0$

For working life 100 years: $f_{bd,fi,100y} = k_{fi,100y}(\theta) \cdot f_{bd,PIR,100y} \cdot \gamma_c / \gamma_{M,fi}$
 with: $\theta \leq 364^\circ\text{C}$: $k_{fi,100y}(\theta) = 30,34 \cdot e^{(\theta \cdot -0,011)} / (f_{bd,PIR,100y} \cdot 4,3) \leq 1,0$
 $\theta > 364^\circ\text{C}$: $k_{fi,100y}(\theta) = 0$

- $f_{bd,fi}$, $f_{bd,fi,100y}$ Design value of the ultimate bond stress at increased temperature in N/mm²
 - θ Temperature in °C in the mortar layer.
 - $k_{fi}(\theta)$, $k_{fi,100y}(\theta)$ Reduction factor at increased temperature.
 - $f_{bd,PIR}$, $f_{bd,PIR,100y}$ Design value of the bond stress in N/mm² in cold condition according to Table C4 considering the concrete classes, the rebar diameter, the drilling method and the bond conditions according to EN 1992-1-1:2011.
 - γ_c = 1,5, recommended partial factor according to EN 1992-1-1:2011
 - $\gamma_{M,fi}$ = 1,0, recommended partial factor according to EN 1992-1-2:2011
- For evidence at increased temperature the anchorage length shall be calculated according to EN 1992-1-1:2011 Equation 8.3 using the temperature-dependent design value of ultimate bond stress $f_{bd,fi}$, $f_{bd,fi,100y}$.

Example graph of Reduction factor $k_{fi}(\theta)$ for concrete classes C20/25 for good bond conditions:

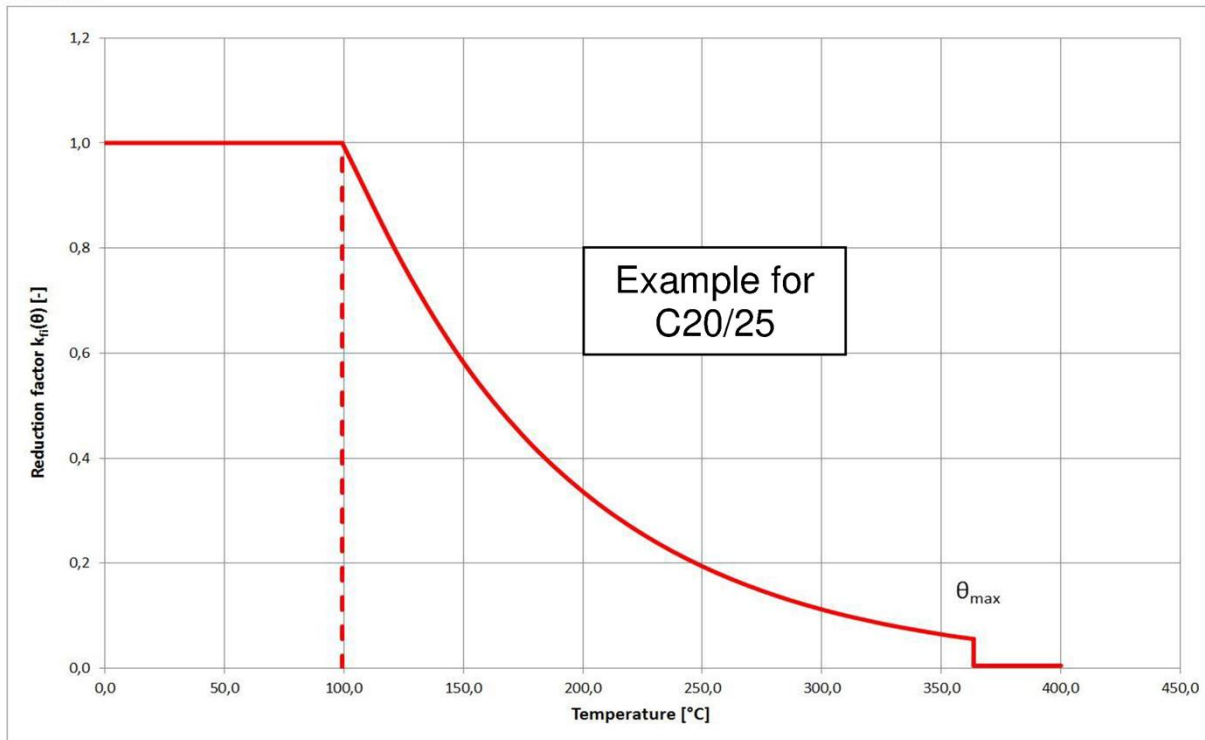

Injection System EJOT Multifix Hybrid / SORMAT ITH Hybrid for rebar connection

Performances
Design value of ultimate bond stress at increased temperature

Annex C 3

Table C8: Characteristic tension resistance for tension anchor ZA under fire exposure							
Tension Anchor				M12	M16	M20	M24
Steel, zinc plated (ZA vz)							
Characteristic tension resistance	R30	$N_{Rk,s,fi}$	[kN]	2,3	4,0	6,3	9,0
	R60			1,7	3,0	4,7	6,8
	R90			1,5	2,6	4,1	5,9
	R120			1,1	2,0	3,1	4,5
Stainless Steel (ZA A4 or ZA HCR)							
Characteristic tension resistance	R30	$N_{Rk,s,fi}$	[kN]	3,4	6,0	9,4	13,6
	R60			2,8	5,0	7,9	11,3
	R90			2,3	4,0	6,3	9,0
	R120			1,8	3,2	5,0	7,2
Injection System EJOT Multifix Hybrid / SORMAT ITH Hybrid for rebar connection				Annex C 4			
Performances Characteristic tension resistance for tension anchor ZA under fire exposure							